



GBG-A/E-O

We invented the popcorn machine
THEN JUST KEPT GOING!

176 MITTEL DRIVE, WOOD DALE, IL 60191

Grab N Go Snack Warmer Operation Manual

208-240 Volt
Single Phase, 50/60 Cycle

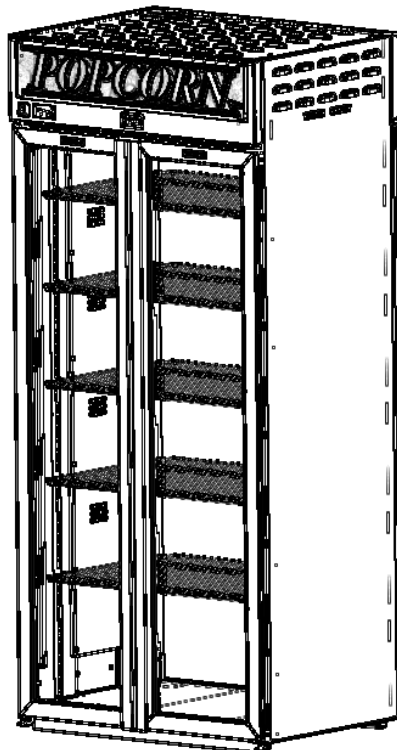

READ and UNDERSTAND these servicing, and safety instructions before servicing this popcorn machine

TABLE OF CONTENTS

I. Safety Alert Symbol.....3

II. Safety First..... 3

III. Introduction.....3

IV. Product Specifications.....4

V. Installation Instructions.....5

VI. Operating Instructions.....6

VII. Sanitation Instructions.....7

I. SAFETY ALERT SYMBOL

The symbol shown below is used to call your attention to instructions concerning your personal safety and the safety of others. Watch for this symbol. It points out important safety precautions. It means **ATTENTION! Become Alert! Your personal safety is involved!** Read the message that follows and be alert to the risk of personal injury or death.



II. SAFETY FIRST

This manual is filled with time-saving and money-saving information regarding your Cretors snack warmer machine. There is nothing more important than the safety aids and warnings that are throughout this document. The Safety Alert Symbol is used to identify topics of primary safety concern wherever they appear.

If, after reviewing this manual, anything is unclear or technical problems are encountered, contact the distributor from whom you purchased your machine for assistance. If there are any additional questions, feel free to contact our Customer Service Department at the address and/or phone number listed on back cover of this manual. Always have the model and serial number of your machine available to assist in obtaining the correct information.



The information in this manual is essential for the safe installation and maintenance of your Cretors snack warmer machine. The manual must be read and understood before installing and operating the equipment, or equivalent training must be provided.



"The employer shall instruct each employee in the recognition and avoidance of unsafe conditions, as well as, regulations applicable to his work environment, to control or eliminate any hazards, or other exposure to illness or injury". Ref.: 29 CFR 1926.20 (b)(4)(a)(2)



It is understood that safety rules within individual companies vary. If a conflict exists between the safety procedures contained in this manual and the rules of a using company, the more stringent rule should take precedence.



IMPORTANT: THIS SNACK WARMER IS NOT FOR THE STORAGE OR DISPLAY OF POTENTIALLY HAZARDOUS FOODS!!!

III. INTRODUCTION

The Grab N Go Warmer is designed to warm and display popped, coated corn and other snack products. The unit is designed with a dual heating blower circuits to circulate warmed air throughout the cabinet. All around corner LED lighting illuminates the storage cabinet. An optional pass thru door is provided for loading each shelf with product from the back access.

The warmer is also equipped with five adjustable shelves. All machines are tested, and are mechanically and electrically sound when they leave the factory.

The warmer is also proved a digital temperature control to allow for various temperature control of stored products. For example, sugar coated product should be kept at cooler set points than savory.

IV. PRODUCT SPECIFICATIONS

CRETORS SNACK WARMER MACHINE: MODEL: GBG

ELECTRICAL SPECIFICATIONS:

208 Volt, Single Phase, 50/60 Cycle 2850 Watts
240 Volt, Single Phase, 50/60 Cycle 3720 Watts

MECHANICAL SPECIFICATIONS:

Net Weight: 384 lbs (174 kgs)

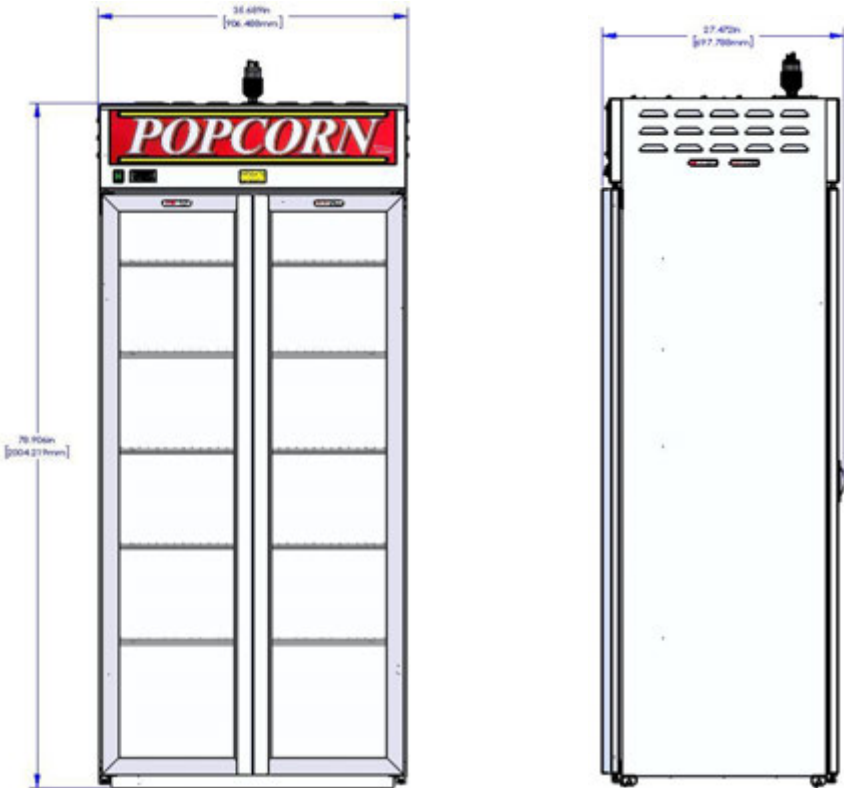

V. INSTALLATION INSTRUCTIONS

1. Location

Choose a location for your Cretors machine to maximize the ease of operation and maintenance procedures. Check your local building and fire codes for location restrictions.

2. Power Supply

Check the nameplate to determine the required power supply.



Connect your warmer only to the correct power source. Failure to do so may result in personal injury or death and may damage your warmer.



Make certain the Rocker Switch on the warmer is in the 'OFF' position when plugging into power source. Failure to do so may result in personal injury or death and may damage your warmer.

3. After Connecting Warmer to Power Supply

The unit's operation can be controlled by the backlit rocker switch located above the pass thru door on the rear of the cabinet.

VI OPERATING INSTRUCTIONS



Do not attempt to operate your Cretors warmer until you have read and understood this manual. Failure to do so may result in serious injury or death.



Do not attempt to operate your Cretors warmer unless the installation instructions have been strictly adhered to. Failure to do so may result in serious injury or death.



Operate your warmer only if it is in sanitary condition (SANITATION INSTRUCTIONS). Failure to do so may result in illness to your customers.

1. Turn Rocker Switch "ON" to light cabinet and turn on heating system.
2. To adjust temperature, press the "SET" button, then the up or down arrow keys to adjust the set point up or down. The controller is set for 150F (66C) and factory set with a range from 65F - 180F (18C - 83C). The unit will not cool so range is actually cabinet ambient to 180F (83C). There is a manual reset high limit set at 200F (93C).

DEPRESS
HERE TO
TOGGLE
POWER
"OFF"

DEPRESS
HERE TO
TOGGLE
POWER
"ON"

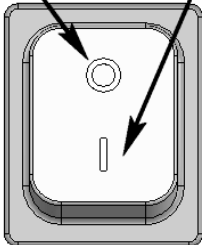

ROCKER SWITCH

PRESS TO
DECREASE
TEMPERATURE
SET POINT
TEMPERATURE

PRESS TO
INCREASE
TEMPERATURE
SET POINT
TEMPERATURE

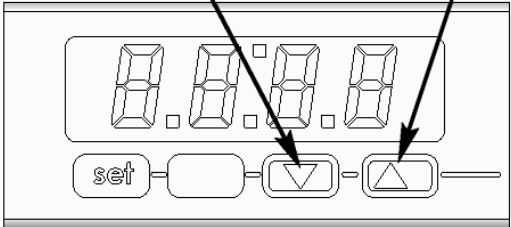

TEMPERATURE CONTROLLER

VII. SANITATION INSTRUCTIONS

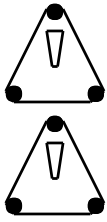

Be certain the machine is turned 'OFF' and power is unplugged before sanitizing this machine. Failure to do so could result in injury or death.



Do not clean heated surfaces until they have been given sufficient time to cool. Failure to do so may result in serious burns.

1. Open the access door(s) either from the front or rear of the warmer and vacuum out scrap daily. Heavy or continuous operation of the machine will require more frequent cleaning. Also make sure that the bottom of the cabinet itself does not have an accumulation of debris. If it does, clean out as required.
2. The cabinet should be cleaned with any good grade glass or household cleaner suitable for stainless steel surfaces. A cleaning agent that is acceptable for food contact surfaces is recommended. Do this as required.
3. The glass can be cleaned with any good grade glass cleaner suitable for glass surfaces.

This manual is filled with time-saving and money-saving information regarding your Cretors snack warmer machine. There is nothing, however, more important than the safety aids and warnings found throughout this document.

If you have any questions regarding the operation or cleaning of your Cretors snack warmer machine, contact your local distributor. Should you have any difficulties or are unable to reach them, feel free to contact the Customer Service Department at C. Cretors and Company.

Additional copies of this manual can be obtained from C. Cretors and Company at the address listed below. Please provide model and serial number when requesting additional copies of this manual. There will be a nominal charge for additional copies.

Cretors guarantees this machine to be free of defects in parts, materials and workmanship for two years. Please take this time to fill out the factory registration card and return it to the factory to activate your warranty. If you have any questions concerning the Cretors' warranty, please contact your local distributor or the Customer Service Department at C. Cretors and Company.



C. CRETORS AND COMPANY
 176 MITTEL DRIVE
 WOOD DALE, IL 60191

PHONE (773) 588-1690, (800) 228-1885, FAX (847) 616-6970

WEB SITE: <http://www.cretors.com> Email: postmaster@cretors.com

Cretors joins the information age! Check out our links <http://www.twitter.com>

<http://www.facebook.com/pages/Chicago-IL/C-Cretors-Co/90143449620>



GBG-A/E-S

We invented the popcorn machine
THEN JUST KEPT GOING!

176 MITTEL DRIVE, WOOD DALE, IL 60191

Grab N Go Snack Warmer Service Manual

208-240 Volt
Single Phase, 50/60 Cycle

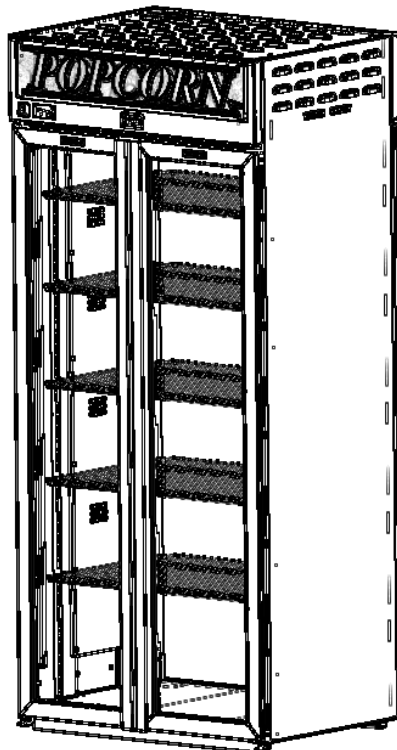

READ and UNDERSTAND these servicing, and safety instructions before servicing this popcorn machine

TABLE OF CONTENTS

I. Safety Alert Symbol.....3

II. Safety First..... 3

III. Introduction.....3

IV. Product Specifications.....4

V. Installation Instructions.....5

VI. Operating Instructions.....6

VII. Service Instructions.....7

VIII. Troubleshooting.....7

IX. Wiring Diagram.....8

I. SAFETY ALERT SYMBOL

The symbol shown below is used to call your attention to instructions concerning your personal safety and the safety of others. Watch for this symbol. It points out important safety precautions. It means **ATTENTION! Become Alert! Your personal safety is involved!** Read the message that follows and be alert to the risk of personal injury or death.



II. SAFETY FIRST

This manual is filled with time-saving and money-saving information regarding your Cretors snack warmer machine. There is nothing more important than the safety aids and warnings that are throughout this document. The Safety Alert Symbol is used to identify topics of primary safety concern wherever they appear.

If, after reviewing this manual, anything is unclear or technical problems are encountered, contact the distributor from whom you purchased your machine for assistance. If there are any additional questions, feel free to contact our Customer Service Department at the address and/or phone number listed on back cover of this manual. Always have the model and serial number of your machine available to assist in obtaining the correct information.



The information in this manual is essential for the safe installation and maintenance of your Cretors snack warmer machine. The manual must be read and understood before installing and operating the equipment, or equivalent training must be provided.



"The employer shall instruct each employee in the recognition and avoidance of unsafe conditions, as well as, regulations applicable to his work environment, to control or eliminate any hazards, or other exposure to illness or injury". Ref.: 29 CFR 1926.20 (b)(4)(a)(2)



It is understood that safety rules within individual companies vary. If a conflict exists between the safety procedures contained in this manual and the rules of a using company, the more stringent rule should take precedence.



IMPORTANT: THIS SNACK WARMER IS NOT FOR THE STORAGE OR DISPLAY OF POTENTIALLY HAZARDOUS FOODS!!!

III. INTRODUCTION

The Grab N Go Warmer is designed to warm and display popped, coated corn and other snack products. The unit is designed with a dual heating blower circuits to circulate warmed air throughout the cabinet. All around corner LED lighting illuminates the storage cabinet. An optional pass thru door is provided for loading each shelf with product from the back access.

The warmer is also equipped with five adjustable shelves. All machines are tested, and are mechanically and electrically sound when they leave the factory.

The warmer is also proved a digital temperature control to allow for various temperature control of stored products. For example, sugar coated product should be kept at cooler set points than savory.

IV. PRODUCT SPECIFICATIONS

CRETORS SNACK WARMER MACHINE: MODEL: GBG

ELECTRICAL SPECIFICATIONS:

208 Volt, Single Phase, 50/60 Cycle 2850 Watts
 240 Volt, Single Phase, 50/60 Cycle 3720 Watts

MECHANICAL SPECIFICATIONS:

Net Weight: 384 lbs (174 kgs)

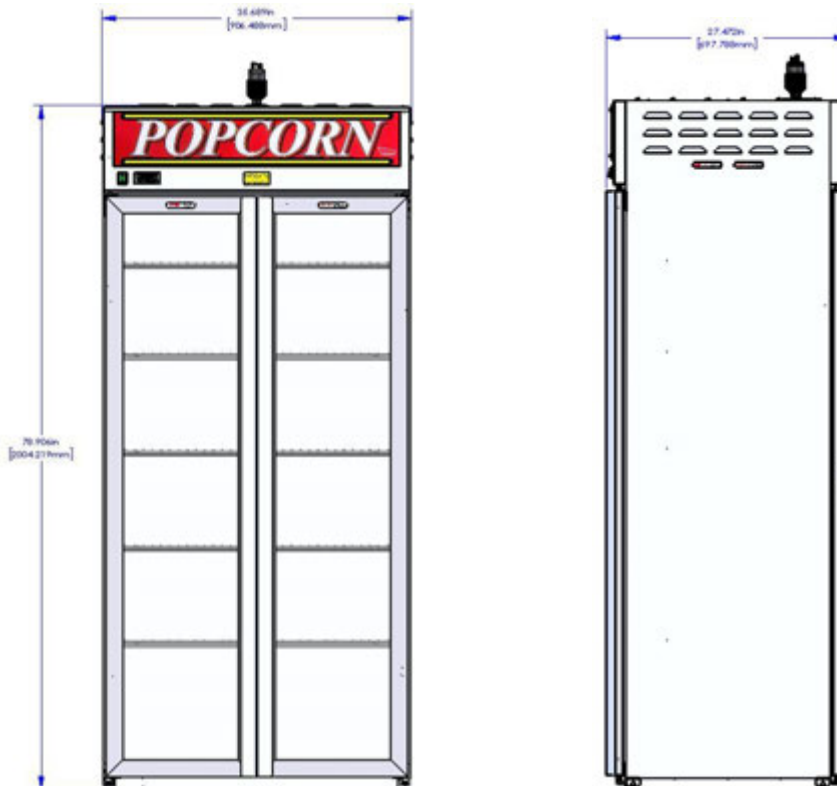

V. INSTALLATION INSTRUCTIONS

1. Location

Choose a location for your Cretors machine to maximize the ease of operation and maintenance procedures. Check your local building and fire codes for location restrictions.

2. Power Supply

Check the nameplate to determine the required power supply.



Connect your warmer only to the correct power source. Failure to do so may result in personal injury or death and may damage your warmer.



Make certain the Rocker Switch on the warmer is in the 'OFF' position when plugging into power source. Failure to do so may result in personal injury or death and may damage your warmer.

3. After Connecting Warmer to Power Supply

The unit's operation can be controlled by the backlit rocker switch located above the pass thru door on the rear of the cabinet.

VI OPERATING INSTRUCTIONS



Do not attempt to operate your Cretors warmer until you have read and understood this manual. Failure to do so may result in serious injury or death.



Do not attempt to operate your Cretors warmer unless the installation instructions have been strictly adhered to. Failure to do so may result in serious injury or death.



Operate your warmer only if it is in sanitary condition (SANITATION INSTRUCTIONS). Failure to do so may result in illness to your customers.

1. Turn Rocker Switch "ON" to light cabinet and turn on heating system.
2. To adjust temperature, press the "SET" button, then the up or down arrow keys to adjust the set point up or down. The controller is set for 150F (66C) and factory set with a range from 65F - 180F (18C - 83C). The unit will not cool so range is actually cabinet ambient to 180F (83C). There is a manual reset high limit set at 200F (93C).

DEPRESS
HERE TO
TOGGLE
POWER
"OFF"

DEPRESS
HERE TO
TOGGLE
POWER
"ON"

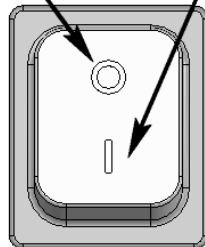

ROCKER SWITCH

PRESS TO
DECREASE
TEMPERATURE
SET POINT
TEMPERATURE

PRESS TO
INCREASE
TEMPERATURE
SET POINT
TEMPERATURE

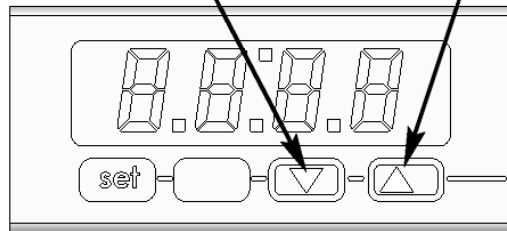

TEMPERATURE CONTROLLER

VII. SERVICE INSTRUCTIONS



In the case of improper operation, qualified personnel only should perform the following diagnostic checks, and, if necessary, corresponding adjustments and repairs. Many of the following procedures present an electrical shock hazard and can cause serious injury or death.

Parts

When ordering parts, refer to the attached parts diagram. Always supply the serial number, model number, and voltage of your warmer.

VIII. TROUBLESHOOTING



Do not attempt electrical repairs on the power supply circuit unless you are qualified to do so. The electrical shock associated with line voltages can cause serious injury or death.

PROBLEM	POSSIBLE CAUSE	ACTION
Warmer will not power up.	Check Power supply.	Is it plugged in?
		Is the receptacle live?
		Is the machine plugged into the proper voltage? Measure with voltmeter and compare to specification on machine.
		Is there power to the rocker switch? If yes, check for loose wiring. Replace rocker switch if cycling of switch does not power up the warmer.
Warmer powers up but supply air is cold.	Bad heating element or high limit safety switch.	Unplug machine. Using a multi-meter, check the resistance of each heat element. Remove the wire from one terminal. The meter should read approximately 32 Ω. If bad, replace the heat element.
	Digital temperature controller has incorrect set point or is malfunctioning.	Plug in machine. Make sure the set point is correct. Then make sure that the temperature controller output light is lit. Check the coil voltage at the heater temperature control contactor and make sure it is receiving 240 volts when the output is lit. If not it can be a defective temperature controller or a loose wire. Check wiring to schematic and replace replace.
	High limit is tripped or stuck open.	Unplug machine. Using a multi-meter, check the continuity of each high limit safety switch. Remove the wire from one terminal. The meter should show continuity. If there is no continuity, replace the high limit safety switch.

IX. WIRING DIAGRAM

DISPLAY WARMER DIGITAL CONTROL
 WIRING DIAGRAM – 230V 50/60Hz.
 BEGINING SERIAL NO. 1810

DOC: GRABnGOr1

10/2018

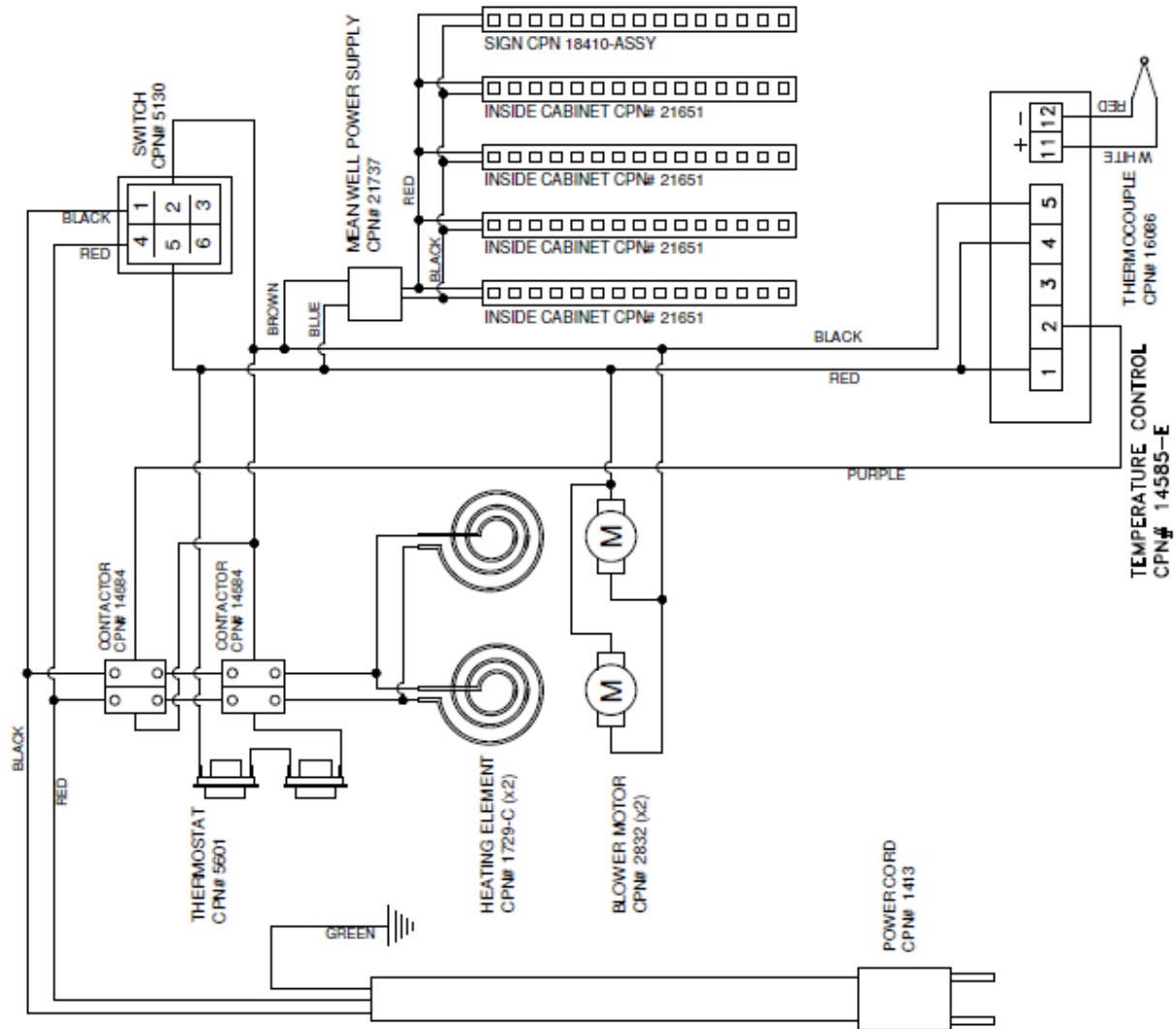

This manual is filled with time-saving and money-saving information regarding your Cretors snack warmer machine. There is nothing, however, more important than the safety aids and warnings found throughout this document.

If you have any questions regarding the operation or cleaning of your Cretors snack warmer machine, contact your local distributor. Should you have any difficulties or are unable to reach them, feel free to contact the Customer Service Department at C. Cretors and Company.

Additional copies of this manual can be obtained from C. Cretors and Company at the address listed below. Please provide model and serial number when requesting additional copies of this manual. There will be a nominal charge for additional copies.

Cretors guarantees this machine to be free of defects in parts, materials and workmanship for two years. Please take this time to fill out the factory registration card and return it to the factory to activate your warranty. If you have any questions concerning the Cretors' warranty, please contact your local distributor or the Customer Service Department at C. Cretors and Company.



C. CRETORS AND COMPANY
176 MITTEL DRIVE
WOOD DALE, IL 60191

PHONE (773) 588-1690, (800) 228-1885, FAX (847) 616-6970

WEB SITE: <http://www.cretors.com> Email: postmaster@cretors.com

**Cretors joins the information age! Check out our links <http://www.twitter.com>
<http://www.facebook.com/pages/Chicago-IL/C-Cretors-Co/90143449620>**

BILL OF MATERIALS			
ITEM #	Default/ QTY.	P/N	DESCRIPTION
1	8	5742	1/4", SAE FLAT WASHER, 18-8 S.S.
2	30	7683	#10, SAE FLAT WASHER, 18-8 S.S.
3	4	2123	BUSHING, HEYCO #2030, 1/4"
4	4	21651	LED STRIP, 60"LG, W/LEADS & POWER SUPPLY
5	8	7760	1/4-20 X 3/4"LG FULLY THD, PHIL TRUSS HEAD MACHINE SCREW, 18-8 S.S.
6	4	7773	#8-32 X 5/8"LG FULLY THD, SLOT TRUSS HEAD MACHINE SCREW, 18-8 S.S.
7	16	7268	#10-32 X 1/2"LG FULLY THD, PHIL TRUSS HEAD MACHINE SCREW, 18-8 S.S.
8	2	7642	#8-32 X 3/8"LG FULLY THD, PHIL TRUSS HEAD MACHINE SCREW, 18-8 S.S.
9	2	21539	STIFFENER, BOTTOM, GRAB-N-GO
10	5	2181	CABLE TIE
11	16	12848	#8 X 3/8"LG, PHIL PAN HEAD TYPE "AB" SMS, STEEL ZINC
12	5	21534	WIRE RACK, GRAB-N-GO WARMER
13	1	21524	CABINET, ASSEMBLY, GRAB-N-GO
14	1	21532	PANEL, TOP, EXTERIOR, GRAB-N-GO
15	20	1968-1	CLIP, PILASTER SHELF, #305
16	1	21650-RH	COVER, INSULATION, RIGHT, BOTTOM, GBG
17	1	21650-LH	COVER, INSULATION, LEFT, BOTTOM, GBG
18	1	21649-RH	COVER, INSULATION, TOP, RIGHT, GBG
19	1	21649-LH	COVER, INSULATION, TOP, LEFT, GBG
20	2	21523	HEATER BOX ASSEMBLY, GRAB-N-GO
21	8	14646	#8-32, KEPS NUT, STEEL NICKEL
22	48	7867	#10-32 X 7/8"LG, SLOT FLAT HEAD MACHINE SCREW, 18-8 S.S.

BILL OF MATERIALS			
ITEM #	Default/ QTY.	P/N	DESCRIPTION
23	8	10514	RIVET, PUSH-IN, HOLE DIA 1/4"
24	1	21519	REAR DOOR, GRAB-N-GO
25	4	21533-RH	HINGE, SELF CLOSING, 4"x2", 40 KG, RIGHT
26	2	21536	DOOR, ASSEMBLY, GRAB-N-GO
27	2	21533-LH	HINGE, SELF CLOSING, 4"x2", 40 KG, LEFT
28	8	16929	#10-32 X 1"LG, PHIL TRUSS HEAD MACHINE SCREW, 18-8 S.S.
29	1	10487	SIGN, "POPCORN", RED & YELLOW, UPDATED LOGO
30	1	21525	LIGHT BOX, GRAB-N-GO WARMER
31	1	21531	BOX, BLANK, GRAB-N-GO
32	1	14585-E	TEMPERATURE CONTROLLER, DIGITAL, 230V
33	1	5130	SWITCH, LIGHTED, 230V
34	1	18410-ASSY	LED STRIP 33.4" WITH LEADS
35	4	21535	BRACKET, CASTER, GRAB-N-GO
36	4	20153	WHEEL, ROUND, CSW-ELV
37	4	20155	PIN, CLEVIS W/ COTTER PIN, ZINC PLATED
38	2	12103	1/2" CONDUIT CONNECTORS
39	3	16129	#54, 5/32" RIVET, DOME HEAD, 0.188-0.250 GR, SS/SS
40	1	1788	CORD, 10AMP, 16-3, NEMA 5-15P
41	1	21538	CONDUIT, POWER CORD, EMT, GRAB-N-GO
42	1	21647	JUNCTION BOX, GBG WARMER
43	1	21648	COVER, JUNCTION BOX, GRAB-N-GO
44	1	2260	CONNECTOR, TWO SCREW, 1/2"

REVISIONS			
REV	DC #	APPROVED BY	APPROVED ON
-	-	-	-
-	-	-	-
-	-	-	-

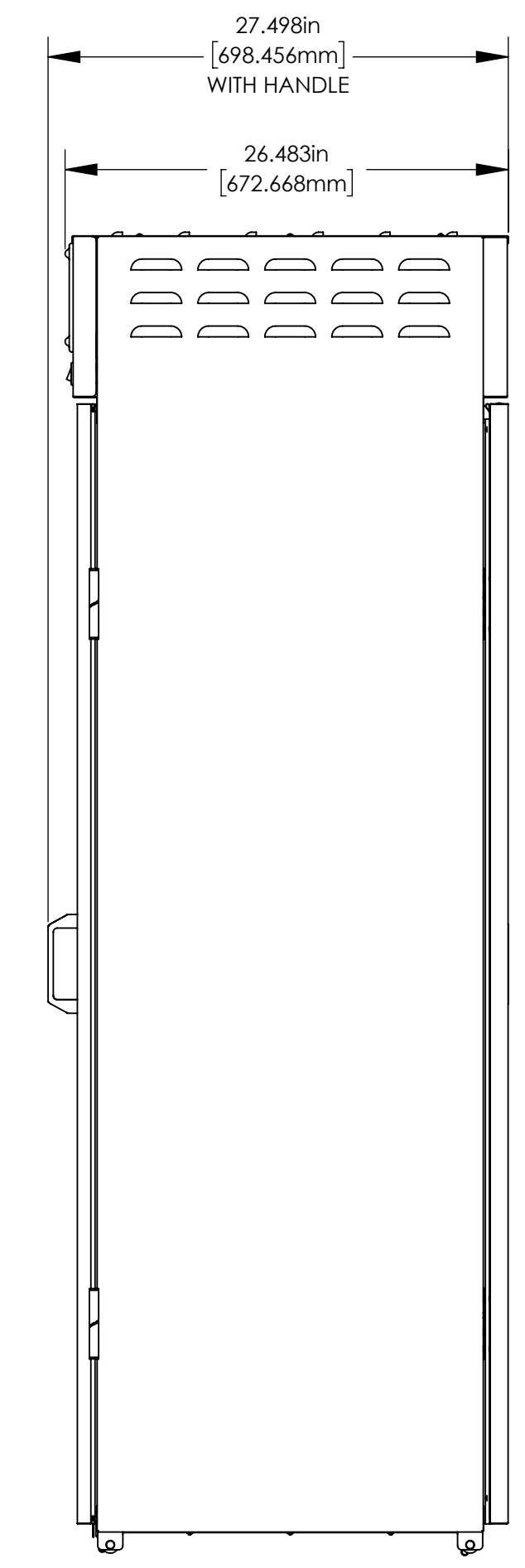
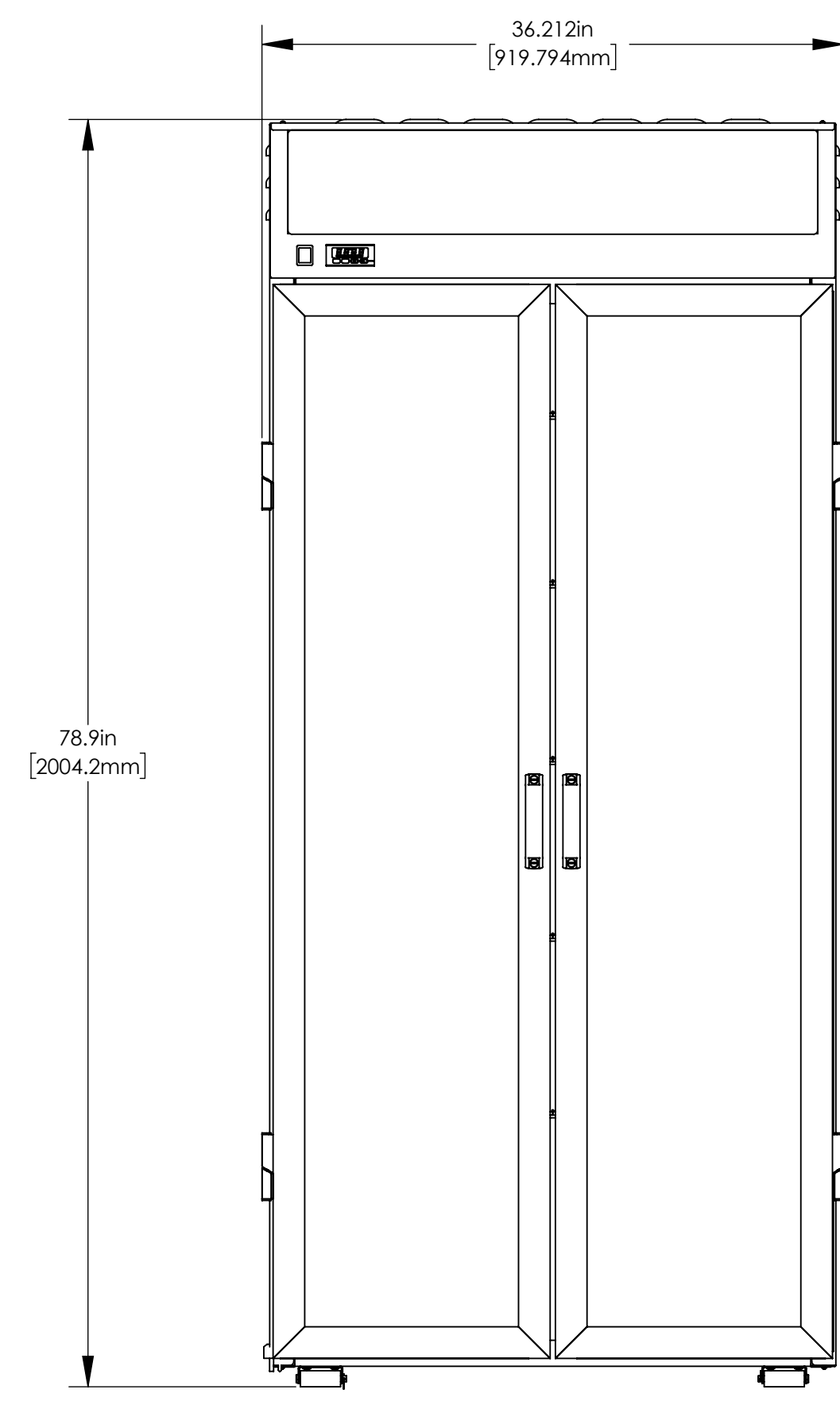
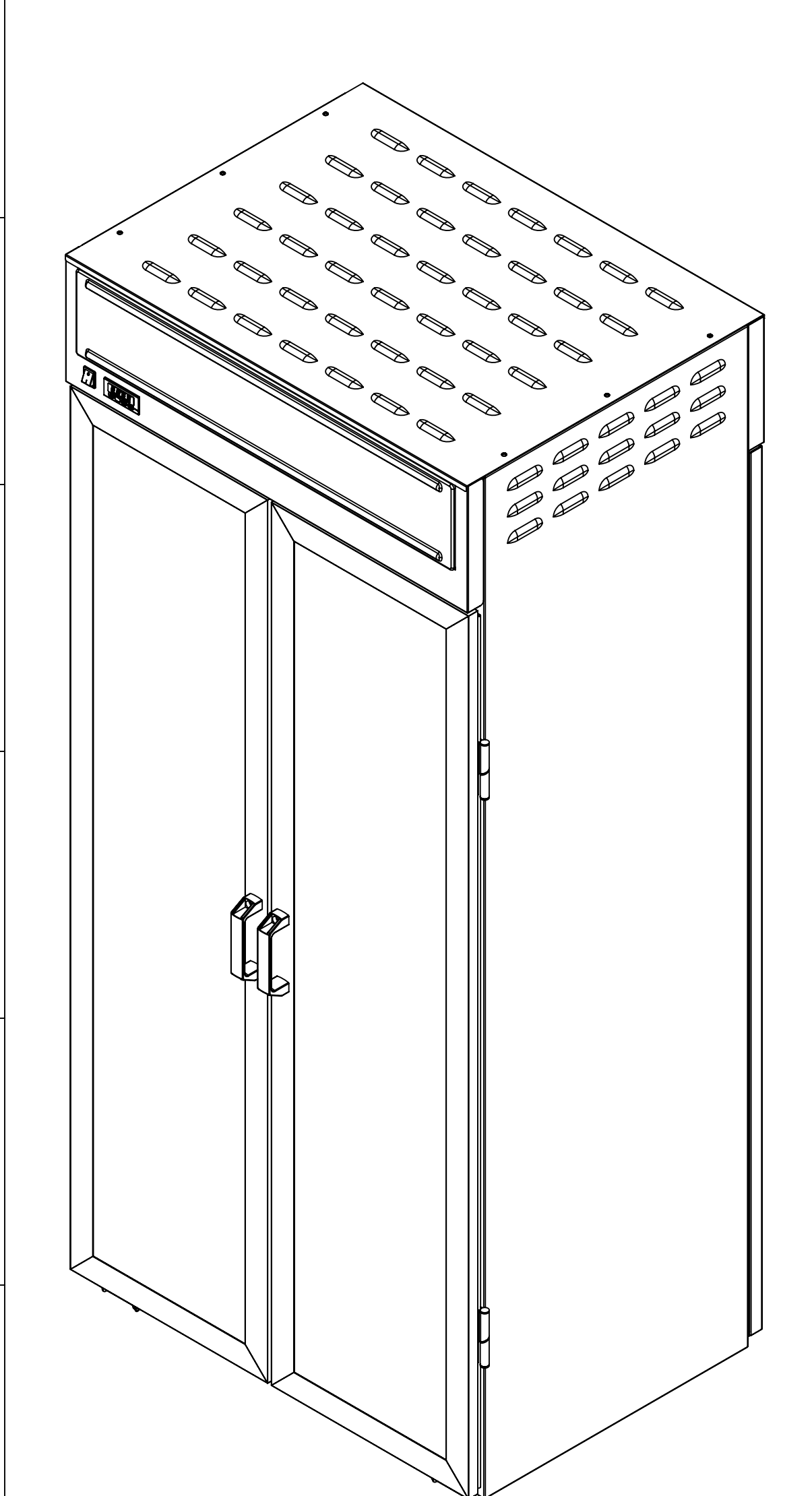

NOTES:
1. XXX.

- STANDARD NOTES:**
1. REMOVE SHARP EDGES AND BURRS.
 2. UNLESS SPECIFIED ALL DIMENSIONS ARE IN INCHES.
 3. REFERENCE DIMENSIONS ARE INDICATED IN PARENTHESIS.
 4. CRITICAL DIMENSIONS THAT NEED INSPECTION ARE INDICATED IN OBOUND BOX.
 5. T.S.C. STAND FOR THEORITICAL SHARP CORNER & INS STAND FOR INSIDE.
 6. FOR SHEET METAL, UNLESS SPECIFIED ALL DIMENSIONS ARE OUTSIDE.
 7. FOR SHEET METAL, FLAT PATTERNS ARE FOR REFERENCE ONLY.
 8. MINOR SCRATCHES ARE ALLOWED ON OPPOSITE SIDE OF MILL FINISH & #4 FINISH.

		THIRD ANGLE PROJECTION				176 MITTEL DRIVE, WOOD DALE, IL 60191 www.cretors.com www.ilo-llnu.com	
TOLERANCES x.xx = ± 0.02 x.xxx = ± 0.01 ANGLES = ± 1° HOLES = +0.005 / -0 FINISH = 125Ra				DESCRIPTION GRAB-N-GO, 230/1/60			
C SIZE DRAWING				MATERIAL REFER INDIVIDUAL SUB-PARTS		APPROX. WEIGHT 366.6 LBS	
DRAWN BY pwozny		DRAWN DATE 10/01/2018		DRAWING NUMBER GBGROF-X		REVISION -	
APPROVED BY _____ APPROVED DATE _____							
THIS DRAWING CONTAINS INFORMATION PROPRIETARY TO C. CRETORS & CO. AND IS FURNISHED IN CONFIDENCE FOR SOLE PURPOSE OF SUPPLYING THE RECIPIENT WITH NEEDED ENGINEERING DATA. THE CONTENTS SHOULD NOT BE DISCLOSED OR REPRODUCED IN ANY MANNER WITHOUT WRITTEN CONSENT OF C. CRETORS & CO. ALL RIGHTS RESERVED.							
							SHEET 1 OF 2

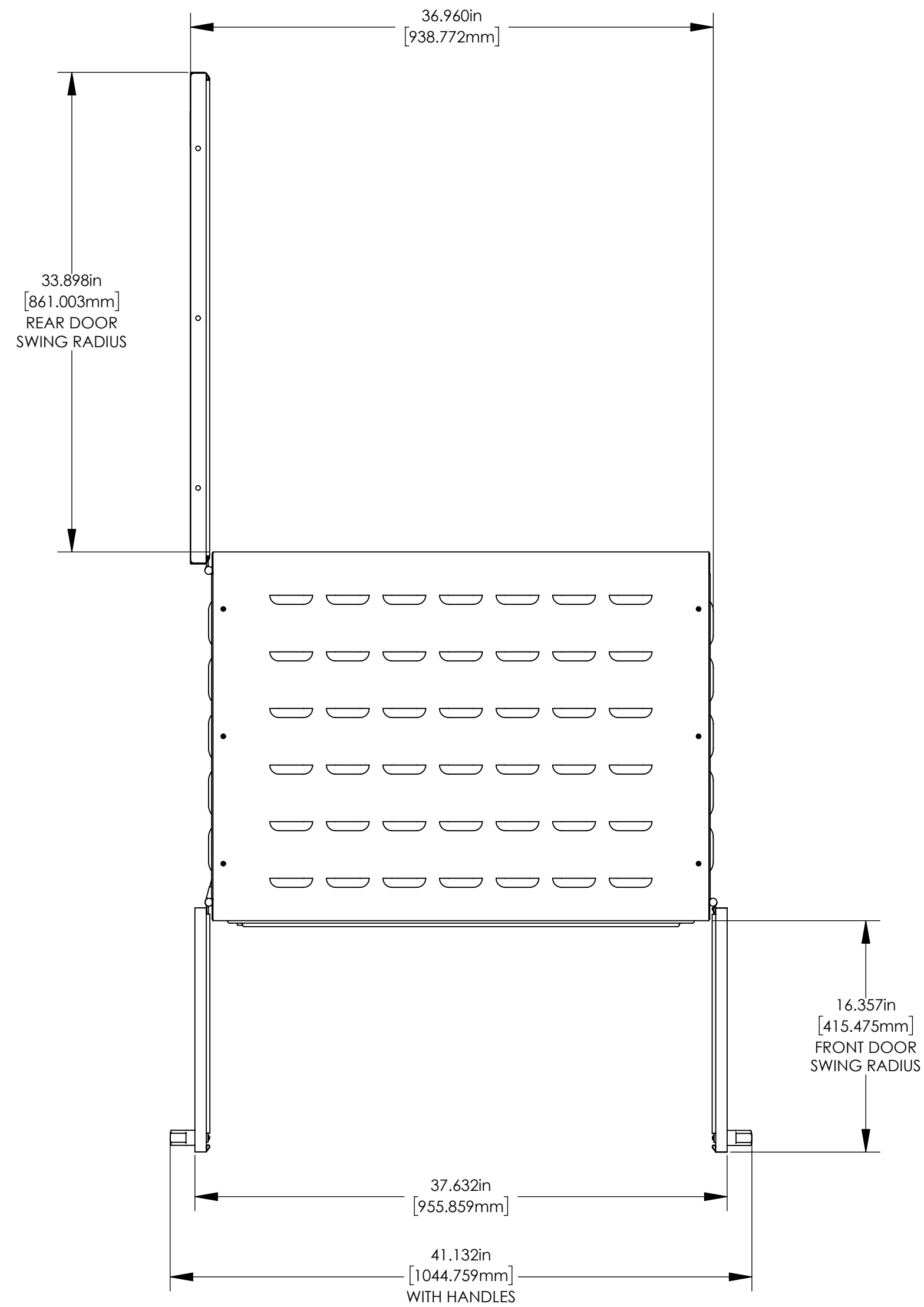

ALL DIMENSIONS ARE WITH DOORS OPEN

- STANDARD NOTES:**
1. REMOVE SHARP EDGES AND BURRS.
 2. UNLESS SPECIFIED ALL DIMENSIONS ARE IN INCHES.
 3. REFERENCE DIMENSIONS ARE INDICATED IN PARENTHESIS.
 4. CRITICAL DIMENSIONS THAT NEED INSPECTION ARE INDICATED IN OBOUND BOX.
 5. T.S.C. STAND FOR THEORITICAL SHARP CORNER & INS STAND FOR INSIDE.
 6. FOR SHEET METAL, UNLESS SPECIFIED ALL DIMENSIONS ARE OUTSIDE.
 7. FOR SHEET METAL, FLAT PATTERNS ARE FOR REFERENCE ONLY.
 8. MINOR SCRATCHES ARE ALLOWED ON OPPOSITE SIDE OF MILL FINISH & #4 FINISH.

THIRD ANGLE PROJECTION		176 MITTEL DRIVE, WOOD DALE, IL 60191 www.cretors.com www.ilo-thru.com	
TOLERANCES x.xx = ± 0.02 x.xxx = ± 0.01 ANGLES = ± 1° HOLES = +0.005 / -0 FINISH = 125Ra		DESCRIPTION GRAB-N-GO, 230/1/60	
C SIZE DRAWING		MATERIAL REFER INDIVIDUAL SUB-PARTS	
DRAWN BY pwozny	DRAWN DATE 10/01/2018	APPROX. WEIGHT 366.6 LBS	
APPROVED BY 		APPROVED DATE 10/01/2018	
		DRAWING NUMBER GBGROF-X	
		REVISION -	
THIS DRAWING CONTAINS INFORMATION PROPRIETARY TO C. CRETORS & CO. AND IS FURNISHED IN CONFIDENCE FOR SOLE PURPOSE OF SUPPLYING THE RECIPIENT WITH NEEDED ENGINEERING DATA. THE CONTENTS SHOULD NOT BE DISCLOSED OR REPRODUCED IN ANY MANNER WITHOUT WRITTEN CONSENT OF C. CRETORS & CO. ALL RIGHTS RESERVED.			
			SHEET 2 OF 2

